

Shelf lighting
ARROW



Shelf lighting

ARROW



- Plug & play (External power supply)
- Wide beam angle
- LEDs pixel free
- Smooth continuous lighting
- Bright and consistent illuminance for display area
- Linkable, max. linkable length: 12' per run
- Lifetime: 50,000hrs (ta=95°F, 35°C)
- Ta: -4°F~95°F (-20°C~35°C)
- 4W/ft, 520lm/ft (@4000K)
- Material: Aluminum alloy
- Other color temp available



Dimensions: (inches/mm)

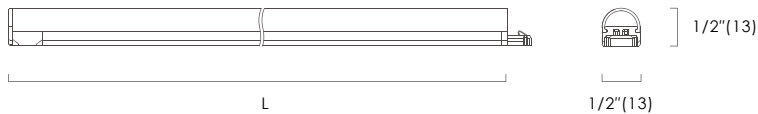

How to order using our catalog numbers

Example: ARROW-1230K110SC0

Series	Length	CCT (K)	Beam Angle	Finish	Installation
ARROW	8 - 7.9"(200mm)	30K - 3000K 40K - 4000K	110 - 110°	S - Silver	C0 - Mounting Clip 0°
	12 - 11.8"(300mm)				
	23 - 22.4"(570mm)				
	35 - 34.3"(870mm)				
	45 - 44.9"(1140mm)				

Specifications

Catalog No.	Model	Rated Input (VDC)	Ra	Power (W)	Luminous flux (TYP@4000K)lm	75W (NA159-7524LA-12A6)	96W (NA383-9624DLA-DG6-12A6)
ARROW-830K110SC0	ARROW-L30-24V	24	85	2.5	325	26pcs ^[1]	33pcs ^[1]
ARROW-840K110SC0							
ARROW-1230K110SC0	ARROW-L48-24V	24	85	4	520	16pcs ^[1]	20pcs ^[1]
ARROW-1240K110SC0							
ARROW-2330K110SC0	ARROW-L90-24V	24	85	7.5	975	8pcs ^[1]	11pcs ^[1]
ARROW-2340K110SC0							
ARROW-3530K110SC0	ARROW-L138-24V	24	85	11.5	1495	5pcs ^[1]	7pcs ^[1]
ARROW-3540K110SC0							
ARROW-4530K110SC0	ARROW-L180-24V	24	85	15	1950	4pcs ^[1]	5pcs ^[1]
ARROW-4540K110SC0							

* Included: 1pc LED fixture, 2pcs Screws, 2pcs Mounting clips, 1pc End cap.
 [1]: Max.Pcs Per UL Listed LED Power Supply. Not to exceed 12' per run.

Photometrics

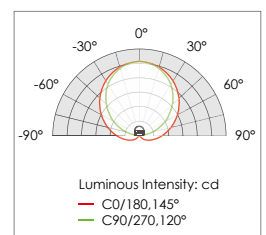

Shelf lighting ARROW

Cone Lux Diagram

Vertical & Horizontal Beamwidth

Center Beam FC

	110°	ARROW-L30-24V		ARROW-L48-24V		ARROW-L90-24V		ARROW-L138-24V		ARROW-L180-24V		
		3000K	4000K	3000K	4000K	3000K	4000K	3000K	4000K	3000K	4000K	
12"		41-5/8"	96	96	155	155	194	194	221	221	219	219
18"		62-3/8"	47	47	75	75	108	108	132	132	135	135
24"		83-1/8"	27	27	44	44	68	68	89	89	95	95
30"		103-7/8"	18	18	10	10	47	47	63	63	69	69
H		D	328 lm	328 lm	520 lm	520 lm	975 lm	975 lm	1495 lm	1495 lm	1950 lm	1950 lm

Accessories

Catalog No.

Description

Length (inch)

IC-AR-59

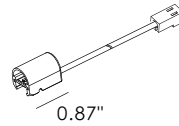

Input cable
(Must be between the light and splitter)

NA159-7524LA-12A6

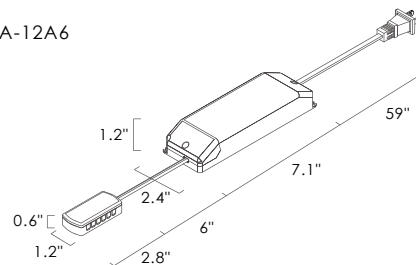

Model: SLT75-24VL-2A
Matching driver, max. 75W.
Input: 100-120VAC NA plug 1 + 59" cable.
Output: 24VDC 12-way splitter JB-12A + 6" cable.



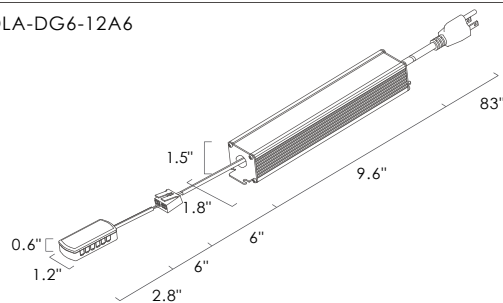

NA383-9624DLA-DG6-12A6



Model: SLD96-24VC-UN1-A
Matching 1-10V dimmable driver, max. 96W.
Input: 120-250VAC NA3 plug + 83" cable.
Output: 24VDC DG238 DEGSON connector + 6" cable + 12-way splitter JB-12A + 6" cable.

Shelf lighting ARROW

Accessories (optional)

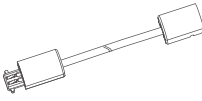
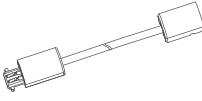
Catalog No.	Description	Length (inch)
MC-AR (included)	 0° mounting clip x 2	-
MC45-AR	 45° mounting clip x 2	-
MMC-AR	 0° magnetic mounting clip x 2	-
MMC45-AR	 45° magnetic mounting clip x 2	-
SC-AR-2	 Soft connector 2"	2"
SC-AR-12	 Soft connector 12"	12"

Installation

0° mounting clip

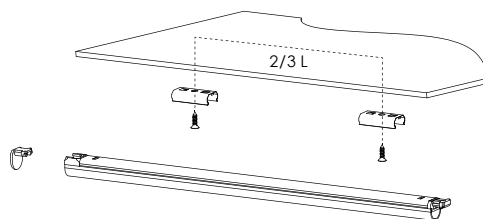

45° mounting clip

