





- Easy installation
- Continuous run installation
- Dimmable, 1-10V dimming to 10%-100%
- Max. linkable length: 96' per run @120VAC, 220' per run @277VAC
- Lifetime: 50,000hrs (ta=95°F, 35°C)
- Ta: -4°F~95°F (-20°C~35°C)
- Material: Aluminum alloy
- 7.5W/ft, 758lm/ft



APPLICATION

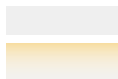
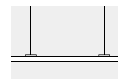
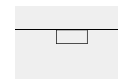
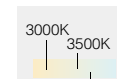

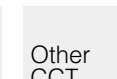
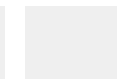
| | | | | | | | |
|--|---|--|--|--|--|---|---|
|  Wide beam angle |  Pixel free |  Pendant mount |  Surface mount |  3000K 3500K 4000K |  50,000hrs |  Other CCT Available |  IP20 |
|--|---|--|--|--|--|---|---|

Dimensions: inches, (mm)

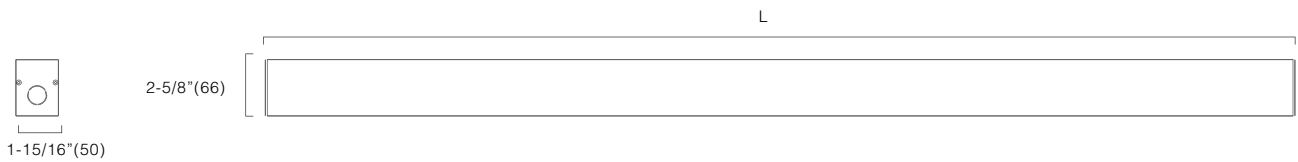

Photometrics

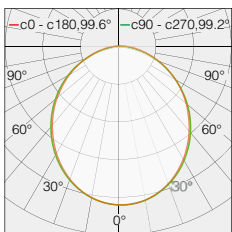

How to order using our catalog numbers

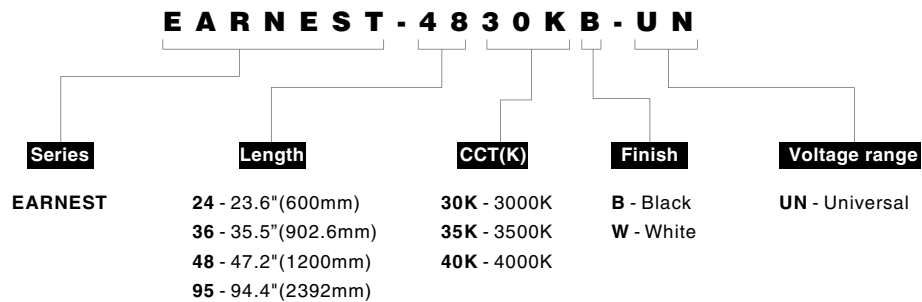





Specifications

| Catalog No. | Model | Rated Input (VAC) | Ra | Power (W) | Length | Beam angle | CCT | Luminous Flux (lm) |
|-------------------|--------------------|-------------------|----|-----------|--------|------------|-------|--------------------|
| EARNEST-2430KB-UN | EARNEST-L600-277V | 120-277 | 92 | 15 | 23.6" | 110° | 3000K | 1442 |
| EARNEST-2435KB-UN | | | | | | | 3500K | 1470 |
| EARNEST-2440KB-UN | | | | | | | 4000K | 1500 |
| EARNEST-2430KW-UN | | | | | | | 3000K | 1442 |
| EARNEST-2435KW-UN | | | | | | | 3500K | 1470 |
| EARNEST-2440KW-UN | | | | | | | 4000K | 1500 |
| EARNEST-3630KB-UN | EARNEST-L925-277V | 120-277 | 92 | 22.5 | 35.5" | 110° | 3000K | 2163 |
| EARNEST-3635KB-UN | | | | | | | 3500K | 2205 |
| EARNEST-3640KB-UN | | | | | | | 4000K | 2250 |
| EARNEST-3630KW-UN | | | | | | | 3000K | 2163 |
| EARNEST-3635KW-UN | | | | | | | 3500K | 2205 |
| EARNEST-3640KW-UN | | | | | | | 4000K | 2250 |
| EARNEST-4830KB-UN | EARNEST-L1200-277V | 120-277 | 92 | 30 | 47.2" | 110° | 3000K | 2883 |
| EARNEST-4835KB-UN | | | | | | | 3500K | 2940 |
| EARNEST-4840KB-UN | | | | | | | 4000K | 3000 |
| EARNEST-4830KW-UN | | | | | | | 3000K | 2883 |
| EARNEST-4835KW-UN | | | | | | | 3500K | 2940 |
| EARNEST-4840KW-UN | | | | | | | 4000K | 3000 |
| EARNEST-9530KB-UN | EARNEST-L2400-277V | 120-277 | 92 | 60 | 94.4" | 110° | 3000K | 5766 |
| EARNEST-9535KB-UN | | | | | | | 3500K | 5880 |
| EARNEST-9540KB-UN | | | | | | | 4000K | 6000 |
| EARNEST-9530KW-UN | | | | | | | 3000K | 5766 |
| EARNEST-9535KW-UN | | | | | | | 3500K | 5880 |
| EARNEST-9540KW-UN | | | | | | | 4000K | 6000 |

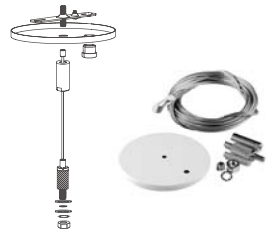
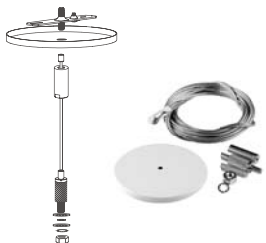

* Included: 1pc led fixture, 2pcs mounting clips.

Accessories

| <i>Catalog No.</i> | <i>Description</i> | <i>Image</i> |
|--|--|---|
| MC-EARNEST (included) Mounting bracket | Mounting bracket x2 |  |
| CR-EARNEST-24 (optional) Cover | Cover roll Length=7.2m(24') |  |
| CR-EARNEST-66 (optional) Cover | Cover roll Length=20m(66') |  |
| HC-EARNEST (optional) Hard Connector | Hard Connector |  |
| AC15-PT (optional) Aircraft cable | Aircraft cable without ceiling plate canopy Length:4.6m(15') |  |
| PFA-PT Power feed assembly | Power feed assembly, including cable coupler (threaded for 1/4-20 stud), cable holder with screw and washer, cable(15'), 1/4-20 hanger bolt, junction box cross bar and 5" ceiling plate canopy with opening in the ceiling plate for the power cord, without power cord Length: 15ft |  |
| ACP-PT Aircraft cable pack | Aircraft cable pack, including cable coupler (threaded for 1/4-20 stud), cable holder with screw and washer, cable(15'), 1/4-20 hanger bolt, junction box cross bar and 5" ceiling plate canopy. Length: 15ft |  |

53 EARNEST Ceiling Lighting

Accessories

| <i>Catalog No.</i> | <i>Description</i> | <i>Image</i> |
|---------------------------------|--------------------|---|
| ECP-EARNEST-B End cap | Endcap, black |  |
| ECP-EARNEST-W End cap | Endcap , white |  |

Installation

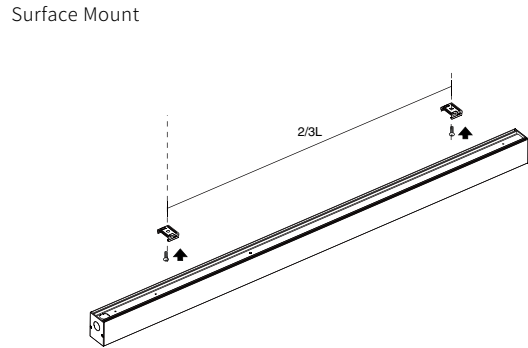
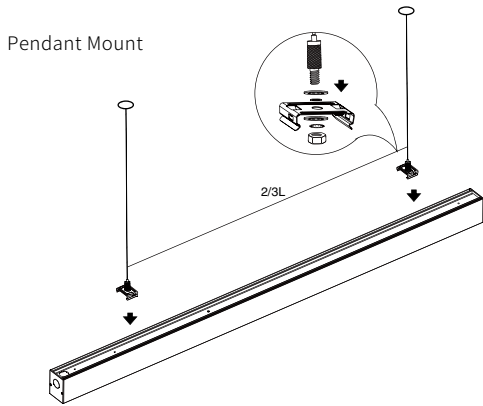

Continuous run installation

